

SDD0-6 Series

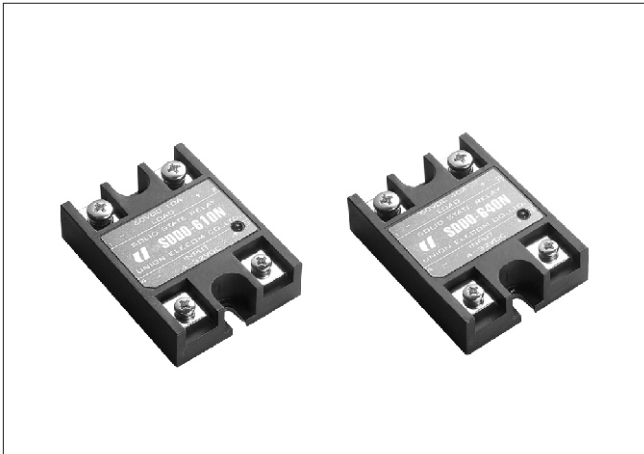

Input DC/Output DC Mold

- 10 - 40Amp DC60V Output
- AC 2500V Isolation
- Normally Open
- LED Indicator
- Panel Mount with Heatsink

SPECIFICATIONS

Item		SDD0-610N	SDD0-620N	SDD0-630N	SDD0-640N	Unit
OUTPUT	DC ON-STATE LOAD CURRENT	10	20	30	40	Adc
	LOAD VOLTAGE RANGE	5 ~ 60				Vdc
	BLOCKING VOLTAGE	100				Vdc
	ON-STATE VOLTAGE DROP	2 Max				Vdc
	OFF-STATE LEAKAGE CURRENT	1 Max				mAdc
INPUT	INPUT VOLTAGE RANGE	4 ~ 32				Vdc
	PICK-UP VOLTAGE	4 Max				Vdc
	DROP-OUT VOLTAGE	1 Min				Vdc
GENERAL	ISOLATION VOLTAGE	2,500Vrms between I/O terminals and case for 1 minute				/
	ISOLATION RESISTANCE	500Vdc 100Mohm between I/O terminals and case				/
	OPERATING TEMPERATURE	-30 ~ +80				°C
	STORAGE TEMPERATURE	-30 ~ +100				°C
	TURN-ON TIME	1 Max				msec
	TURN-OFF TIME	1 Max				msec

BLOCK DIAGRAM

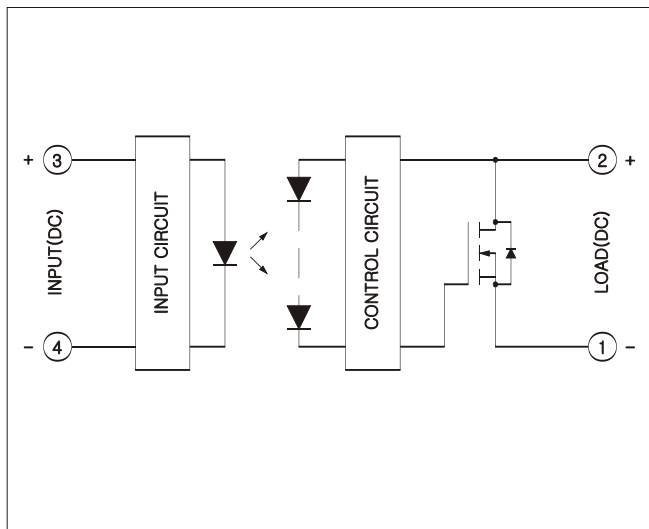

DIMENSIONS(UNIT : MM)

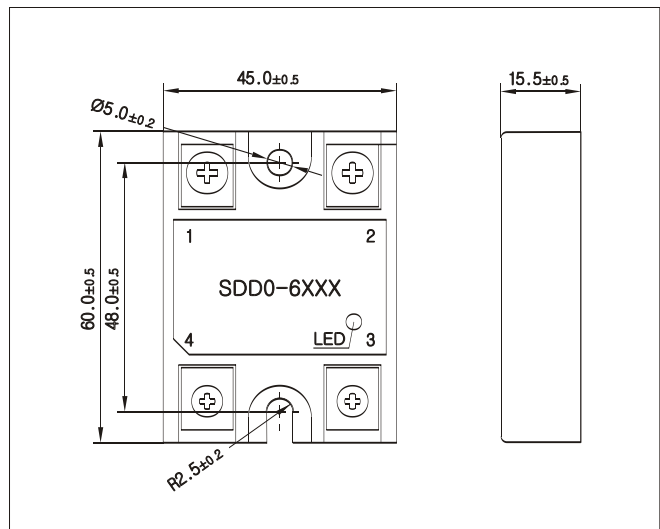

Characteristic curve

A. 10Amp S.S.R

S.S.R Model

SDD0-110N/210N/610N

Heatsink

(1)Infinite(2)UHS118-1-45(3)Non

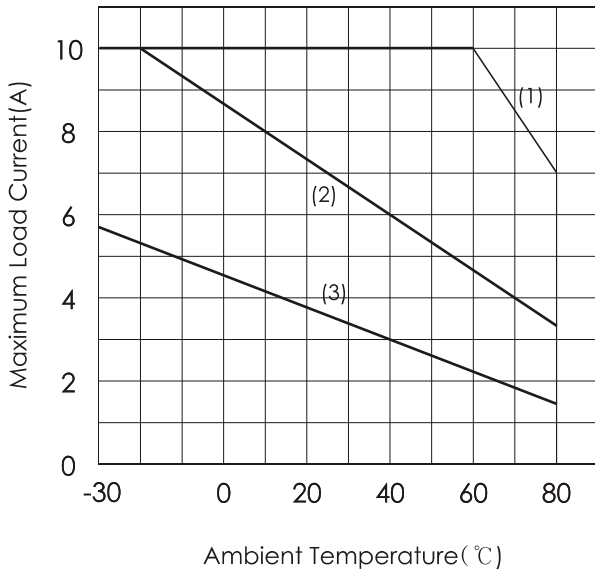

B. 20Amp S.S.R

S.S.R Model

SDD0-120N/220N/620N

Heatsink

(1)Infinite(2)UHS118-1-60(3)Non

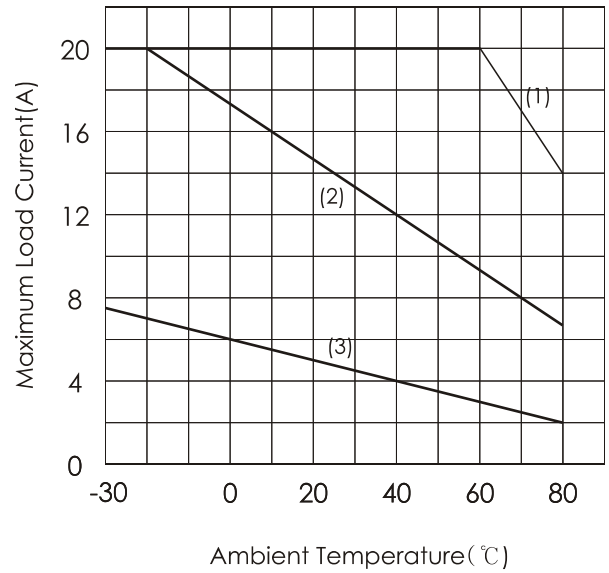

C. 30Amp S.S.R

S.S.R Model

SDD0-130N/230N/630N

Heatsink

(1)Infinite(2)UHS118-1-80(3)Non

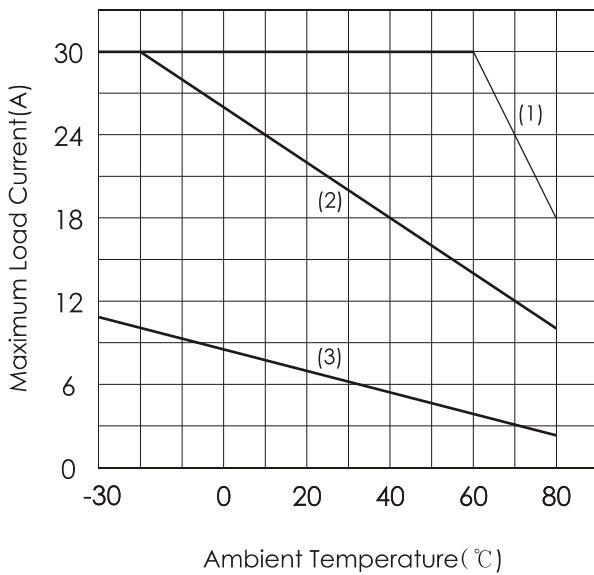

D. 40Amp S.S.R

S.S.R Model

SDD0-140N/240N/640N

Heatsink

(1)Infinite(2)UHS118-1-80(3)Non

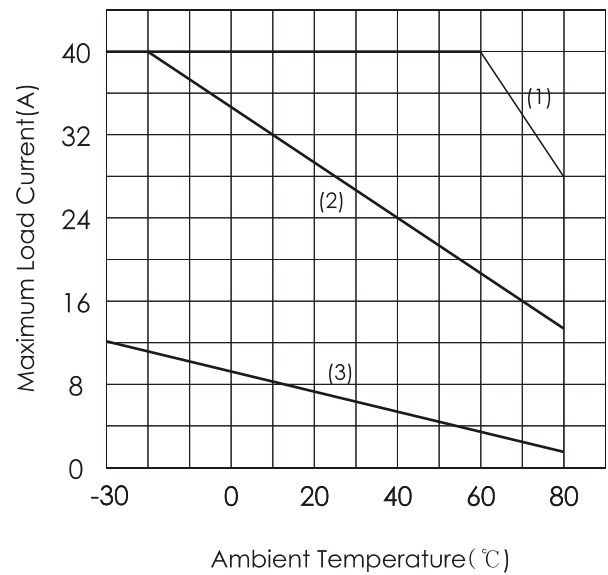

Standard heatsink

1) UHS118 Series

	MODEL	Length(mm)
	UHS118-1-45	45
	UHS118-1-60	60
	UHS118-1-80	80
	UHS118-3-120	120
	UHS118-3-150	150

2) UHS11 Series

	MODEL	Length(mm)
	UHS11-1-80	80
	UHS11-1-105	105
	UHS11-3-80	80
	UHS11-3-105	105
	UHS11-3-150	150

3) UHS120V80-3-110

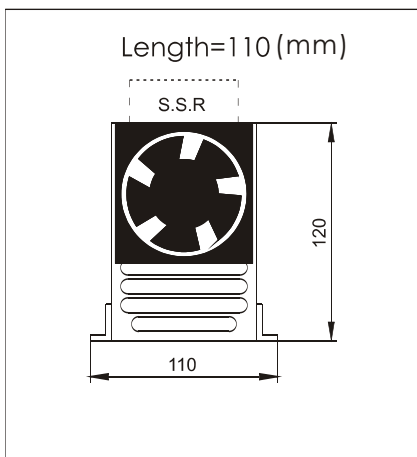

4) UHS124V128-3-105

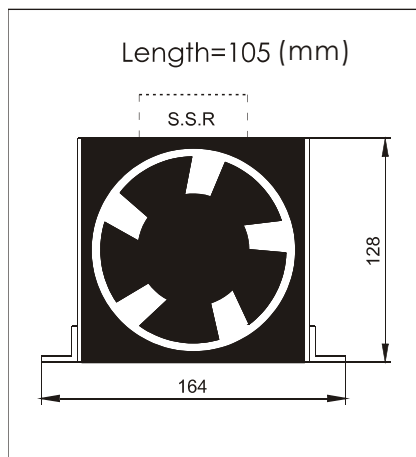

5) UHS126-P

MODEL	Length(mm)
UHS126-P-40	40
UHS126-P-50	50